

Control Power Transformer

Model CPTS3-60-10

CPTS5-95-10 rev 050919

CERTIFICATIONS:



FREQUENCY:

60 Hz.

THERMAL RATING:

10 kVA at 30°C. ambient

8.6 kVA at 55°C. ambient

STANDARD SECONDARY VOLTAGE:

120 volts

INSULATION LEVEL:

CPT3:

5 kV, 60 kV BIL full wave.

CPT5:

15 kV, 95 kV BIL full wave.

APPROXIMATE WEIGHT:

250 lbs.

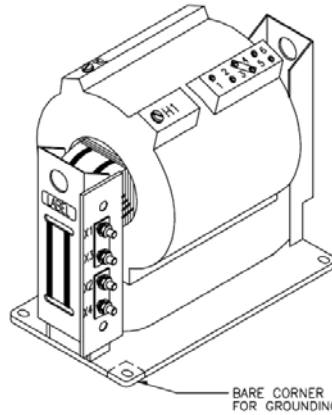

- Primary terminals are ¼-20 brass screws with one flat washer and star washer.
- Secondary terminals are brass studs ½-13 with one flat washer, lock washer and two nuts, plus series/parallel links.
- The transformer High Voltage winding is vacuum encapsulated in epoxy resin.

- Supplied with 1±7-1/2% or 2±2-1/2% taps above & below nominal voltage on the primary winding.
- Available as unfused only.
- Self cooled.
- Steel mounting base.
- For indoor use.

***CATALOG NO.	PRIMARY VOLTAGE	RATIO	SECONDARY VOLTAGE	**FUSE RATING
CPTS3-60-10-242	2400	20:1	120/240	15E
CPTS3-60-10-4161	4160	34.7:1	120/240	7E
CPTS3-60-10-482	4800	40:1	120/240	7E
CPTS5-95-10-722	7200	60:1	120/240	5E
CPTS5-95-10-842	8400	70:1	120/240	5E
CPTS5-95-10-123	12000	100:1	120/240	3E
CPTS5-95-10-1242	12470	104:1	120/240	3E
CPTS5-95-10-1322	13200	110:1	120/240	3E
CPTS5-95-10-1382	13800	115:1	120/240	3E
CPTS5-95-10-1442*	14400	120:1	120/240	3E

*Not available with primary taps.

**Note all fuse ratings are based upon NEC transformer overcurrent protection recommendations. Specific applications may require other ratings.

***For 1±7-1/2% taps use suffix "A" after Catalog No.

***For 2±2-1/2% taps use suffix "B" after Catalog No.

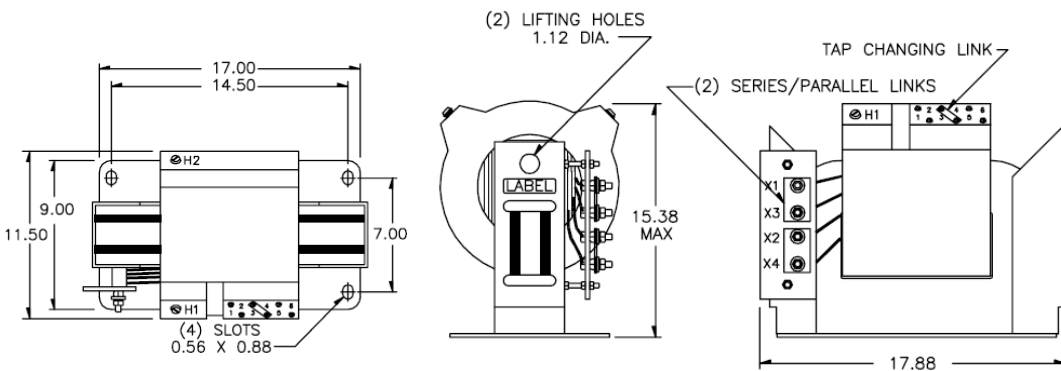
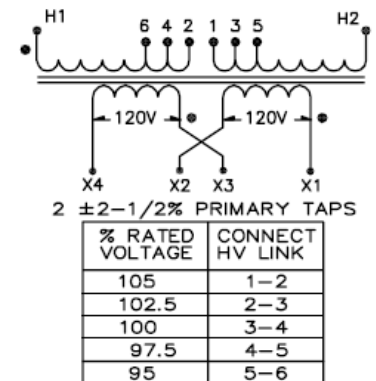
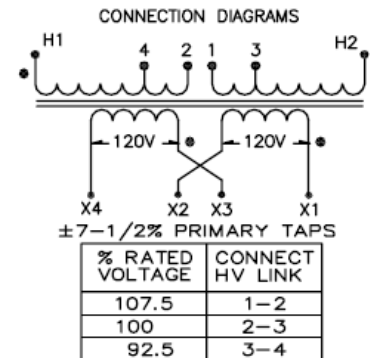

Products are manufactured in a plant whose quality management system has been certified to be in compliance with ISO 9001:2015 by NQA